



SeQual® Workhorse-15

PSA Oxygen Concentrator System



INSTRUCTION MANUAL

WORKHORSE SERIES

Tables of Contents

1.0 Introduction

1.1	GENERAL	5
1.2	CAUTIONS, WARNINGS AND HAZARDS	5
1.3	PATENTS, TRADEMARKS AND COPYRIGHT	6

2.0 Installation

2.1	OXYGEN HOOK-UP	7
2.2	COMPRESSOR INLET FILTER	8

3.0 Operation

3.1	GENERAL	9
-----	---------	---

4.0 Maintenance

4.1	GENERAL	11
-----	---------	----

5.0 Troubleshooting

5.1	GENERAL	13
-----	---------	----

6.0 Technical Data

6.1	SPECIFICATIONS	15
6.2	DRAWINGS AND SCHEMATICS	16

7.0 Service Parts

7.1	SERVICE PARTS	17
7.2	REPLACEMENT TUBING	18
7.3	TECHNICAL SUPPORT	18

List of Figures and Tables

Table 6.1:	Workhorse-15 Specifications	15
Figure 6.1:	Mechanical Outline Drawing - Workhorse-15	16
Table 7.1:	Workhorse-15 Service Parts	17
Table 7.2:	Replacement Tubing	18

1.0 Introduction

1.1 GENERAL

The operation of the Workhorse Oxygen Concentrator is based on the pressure swing adsorption (PSA) cycle using synthetic zeolite molecular sieve. The Workhorse Oxygen Concentrator is capable of delivering oxygen flows up to 15 standard cubic per hour (SCFH) / 7.1 liters per minute (LPM) at over 90% by volume oxygen concentration. The main components of the Workhorse Oxygen Concentrator are a SeQual ATF Oxygen Concentrator Module and an oil-less air compressor.

Typical applications for the Workhorse Oxygen Concentrator include aquaculture and ozone generation for water treatment. AirSep can supply oxygen systems ranging in capacity from 8 SCFH to 5,500 SCFH).

1.2 CAUTIONS, WARNINGS AND HAZARDS

Oxygen is a powerful oxidizing agent. Material that burns in air and even some material that will not burn in air are easily ignited and burn rapidly in high concentrations of oxygen. For safety concerns, all possible sources of ignition must be kept away from the oxygen concentrator and preferably out of the room in which it is being used. Observe strict cleanliness procedures when fabricating and connecting the oxygen piping. It is imperative that oxygen systems be properly cleaned and inspected to insure that no combustible materials remain in the system. Do not allow the free flow of oxygen from any ATF module or from any point on the oxygen manifold.

Ensure that the Workhorse Oxygen Concentrator is in a well ventilated area. If the space is occupied, sufficient ventilation must be provided to prevent the accumulation of low oxygen concentration waste gas in the space.

Do not allow rain or condensation to contact the Workhorse Oxygen Concentrator. The Workhorse Oxygen Concentrator is not weather proof. It must be operated indoors or in an enclosure in a non-condensing environment.

The Workhorse Oxygen Concentrator should be installed and operated per the Compressed Gas Association Guide P-8.1–2016 “Safe Installation and Operation of PSA and Membrane Oxygen and Nitrogen Generators.”

1.3 PATENTS, TRADEMARKS AND COPYRIGHT



The Workhorse Oxygen Concentrator is protected by the following US Patents:

- 4,925,464
- 5,112,367
- 5,114,441
- 5,268,021
- 5,366,541
- 5,593,478
- Re. 35,099
- Other patents pending

2.0 Installation



A wall bracket has been supplied with the system. Install the bracket on a sturdy vertical surface using a level. Attach the bracket with bolts or screws capable of supporting the unit. The backplate of the unit has large through holes for sighting in the wall bracket's hanger screws. If necessary, remove the top cover and use the through holes to assist the installer hanging the unit. Re-attach the cover. Do not lay items on the cover; it is not designed to carry heavy loads.

Be certain there is sufficient access space around the Workhorse Oxygen Concentrator to perform normal maintenance and service. Also ensure there will be a free flow of cooling air around the unit. Connect the unit to a grounded power source rated for the voltage and current requirements stated on the label on the unit.

	<p>There are packaging materials that must be removed from inside the Workhorse enclosure before operation. Do not attempt to operate the Workhorse Oxygen Concentrator without removing these packaging materials, as severe damage will result.</p>
	<p>The location of the Workhorse Oxygen Concentrator must be well ventilated to prevent suffocation of personnel. Refer to the recommendations in the Compressed Gas Association Guide P-8.1–2016 “Safe Installation and Operation of PSA and Membrane Oxygen and Nitrogen Generators.”</p>
	<p>Choose a location for the Workhorse Oxygen Concentrator that does not allow rain or condensation to contact the unit. The Workhorse Oxygen Concentrator is not weather proof. It must be operated indoors or in an enclosure in a non-condensing environment.</p>

2.1 OXYGEN HOOK-UP

The oxygen outlet connection is $\frac{1}{8}$ " female National Standard Pipe Thread (NPT) and is located on the front of the Workhorse Oxygen Concentrator. The hex nut bulkhead fitting should be stabilized with a $\frac{7}{8}$ " wrench to prevent rotation when making your connection to the unit.

	<p>Oxygen is a powerful oxidizing agent. Material that burns in air and even some material that will not burn in air are easily ignited and burn rapidly in high concentrations of oxygen. For safety concerns, all possible sources of ignition must be kept away from the oxygen concentrator and preferably out of the room in which it is being used. Observe strict cleanliness procedures when fabricating and connecting the oxygen piping. It is imperative that oxygen systems be properly cleaned and inspected to insure that no combustible materials remain in the system. If you are not familiar with oxygen cleaning procedures, refer to the Compressed Gas Association documents G-4.1–2018 “Cleaning Equipment for Oxygen Service” and G-4.4 “Industrial Practices for Gaseous Oxygen Transmission and Distribution Piping Systems.”</p>
	<p>Do not allow the free flow of oxygen from the Workhorse Oxygen Concentrator. Ensure that the oxygen flow is measured and controlled to rates that do not exceed rated capacity.</p>

2.2 COMPRESSOR INLET FILTER

The compressor inlet filter may have been removed to protect from shipping damage. If so, install the compressor inlet filter prior to starting up the unit.

3.0 Operation

3.1 GENERAL

If the Workhorse Oxygen Concentrator is supplied with a cover, make certain the fan cord is connected to the fan on the cover, before reinstalling the cover. The length of the cord provides for cover removal without disconnecting the cord from the fan.

To start the Workhorse Oxygen Concentrator, connect the unit to a grounded power source rated for the voltage and current requirements stated on the label on the unit. Push the toggle switch on the front panel to the up position. [The green LED on the front panel of the unit will light, indicating that power is applied to the system, and the red LED will light indicating low oxygen concentration.]

Set the outlet oxygen flow to 15 SCFH (7 LPM) or less. [When the oxygen concentration achieves 70% the red LED will go out and a yellow LED will light. When the concentration is greater than 85%, the yellow LED will go out.]

[The visual LED alarms also correspond to two alarm outputs on the nine pin D-sub connector located under the LEDs. These outputs are Form A one amp dry contacts. They are normally open and then close during an alarm. Only one contact is closed at any time during an alarm. If the oxygen concentration falls below 85%, the yellow LED will light and pins 4 and 5 will close. If the concentration falls below 70%, these contacts will open and the yellow LED will turn off. The red LED will then light and pins 2 and 3 will close.]

[Pins 1 and 6 can be used to measure the concentration level to within $\pm 2\%$ of concentration. This is read by placing the negative lead of a digital voltmeter on pin 1 and the positive lead on pin 6. A 0-1 volt output is displayed with one volt relating to 100% and zero volts relating to 0%. Audible and visual alarms, automatic phone dialers and digital oxygen purity displays that directly interface with the nine pin connector are available as accessories. Contact AirSep for additional information.]
[] Applies to models with optional oxygen monitor.



The flow meter installed on the Workhorse Concentrator is set to read accurately when the discharge is to atmospheric pressure. If the actual discharge pressure is substantially above atmospheric pressure, the reading can be adjusted to determine the precise flow rate, according to the following formula:

$$(\text{adjusted flow}) = (\text{measured flow}) \times \frac{\sqrt{\text{oxygen pressure} + 14.7}}{14.7}$$

Please contact AirSep Technical Support if additional assistance is required.

Do not allow the oxygen product to vent freely. Do not exceed rated capacity.

4.0 Maintenance

4.1 GENERAL

The Compressor Inlet Filter should be changed every 4,000 hours. Filter change frequency is dependent upon environmental conditions and may vary.

Compressors require a rebuild between 5,000 to 12,000 hours of operation depending on environmental conditions.

See the Service Parts section for information on replacement air inlet filters and compressor rebuild kits.

5.0 Troubleshooting

5.1 GENERAL

In the image below, a pressure gauge (typically up to 50 psig (3.4 barg)) is shown on the air input to the ATF and another pressure gauge (typically 30 psig (2 barg)) is shown on the oxygen output measured between the ATF and flow meter.

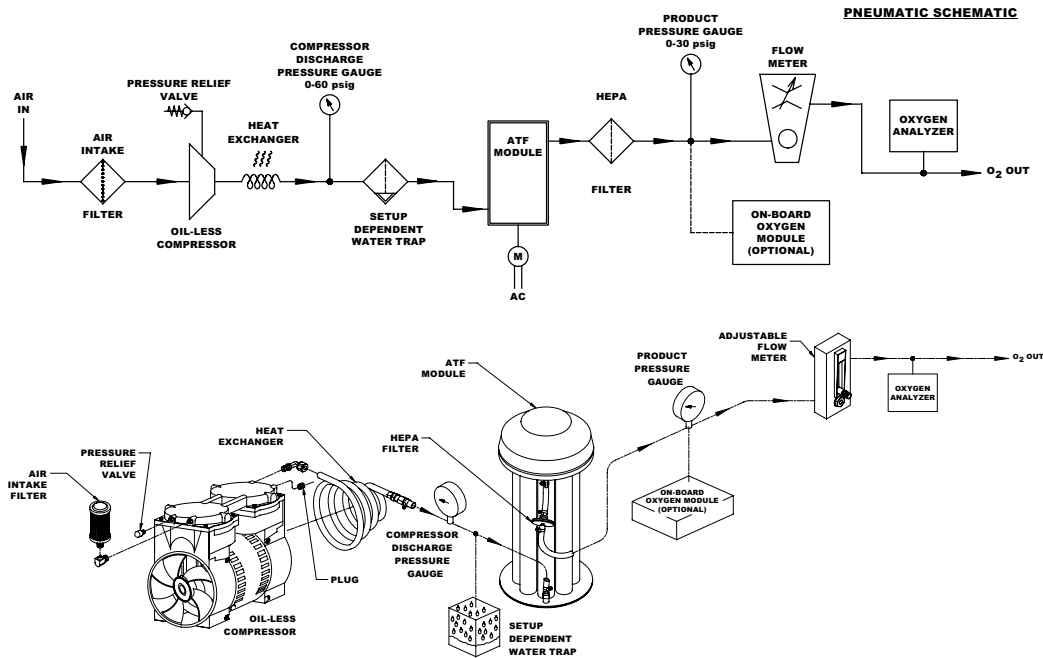

In our normal operation of an ATF, the input and output pressures should be within about 2 psig of what they were when the unit was new. Sometimes a snubber or dampener is necessary to keep the gauge readable, or a glycerin-filled gauge can be used, especially on the air input side. Also, the oxygen concentration should be between 90-95% throughout the rated flow range.

For the specific psig measurements, please compare to readings when the unit was new. Visit www.airsepcpd.com or contact AirSep.

Generally, if the pressures are low and the concentration is low, the order of checking is:

1. Does the intake filter on the compressor need to be changed?
2. Is there a leak? Snoop can be used at all of the pressurized fittings. It should of course not be used on the fittings at the intake side of the compressor, because a leak there is relatively inconsequential, and it is bad to pull liquid into the compressor.
3. Does the compressor need a rebuild?

Generally, if the pressures are high and the concentration is low, the order of checking is:

1. Is the motor on the ATF rotating?
2. Is the motor on the ATF rotating at the correct speed? By wiping off the spindle and making a mark, the rotation can be observed. Typically, it should be at 2-4 RPM, so it can be timed for 15 or 30 seconds, or a full rotation can be timed. Compare to the time marking (in seconds) on the side of the gear motor or contact AirSep for the correct RPM.
3. Is the ATF contaminated with water or oil (if an oil-lubricated compressor is being used)?

If the pressure relief valve is audibly actuating, it is either a sign that the pressures are high, or that the pressure relief valve has drifted from its preset point and requires replacement.

If water contamination is suspected, the weight of the ATF can be compared with its weight when it shipped from AirSep.

Other symptoms:

If the pressures are fluctuating more than about 2 psig around the median, it could indicate an internal rupture or a previous incidence of the motor not turning. If the pressure fluctuates more than 3 psig on the air input, this might indicate that one or more of the flow-controlling orifices inside is compromised. That would mean when the cycle pressurizes these beds, the flow is higher than normal and the pressure goes down.

Alternatively, if there was an electrical discontinuity or other valve stoppage for a period of time while air was being introduced or a vacuum was drawn from the product end (like from an injector), some of the beds may be contaminated. When the cycle pressurizes these beds, the flow is lower than normal and the pressure goes up.

The best way to confirm the oxygen is a direct oxygen concentration measurement perhaps with a hand-held device like the MiniOx. Information about them can be found at www.msanet.com. Salter Labs has one called the PrO2 Check Elite at www.salterlabs.com that not only checks concentration but also flow and pressure.

6.0 Technical Data

6.1 SPECIFICATIONS

Workhorse-15	
Performance Data	
Product Flow ¹	15 SCFH (.39 Nm ³ /hr or 7.1 LPM)
Oxygen Delivery Pressure	7 psig (48 kPa or 0.48 barg)
Product Concentration	90% +3%/-5%
Product Dew Point	-100°F (-73°C)
Dimensions (W x D x H) (nominal)	14 x 18 x 22 in (36 x 46 x 55 cm) (maximum dimensions without cover)
Weight (without cover)	49 lb (22 kg)
Physical Connections	
Product Gas Outlet	1/8" FNPT
Ambient Operating Conditions	Locate the oxygen concentrator system in a well-ventilated area that is protected from weather elements and remains between 40°F (4°C) and 110°F (43°C) inside room or operating enclosure; -20°F (-29°C) and 170°F (77°C) in storage
Control Power Requirements (Single Phase)	120 V ~ ±10%, 60 Hz, 5.0 A 230 V ~ ±10%, 50 Hz, 2.5 A 230 V ~ ±10%, 60 Hz, 2.5 A
Typical Power Consumption	600 W
Compressed Air	Pressure Relief Valve setting: 35 psig ±10%
Environment	<ul style="list-style-type: none"> Barometric Pressure Range: 28-31" of Hg Ambient Oxygen Concentration: 20% minimum

¹SCF (Standard cubic foot) gas measured at 1 atmosphere and 70°F / Nm³ (Normal cubic meter) gas measured at 1 atmosphere and 0°C / LPM (Liters per minute) gas measured at 1 atmosphere and 21°C.

*All performance ratings based on an ambient temperature up to 100°F (38°C), up to 1,000 feet elevation, and 80% relative humidity.

Table 6.1: Workhorse-15 Specifications

6.2 DRAWINGS AND SCHEMATICS

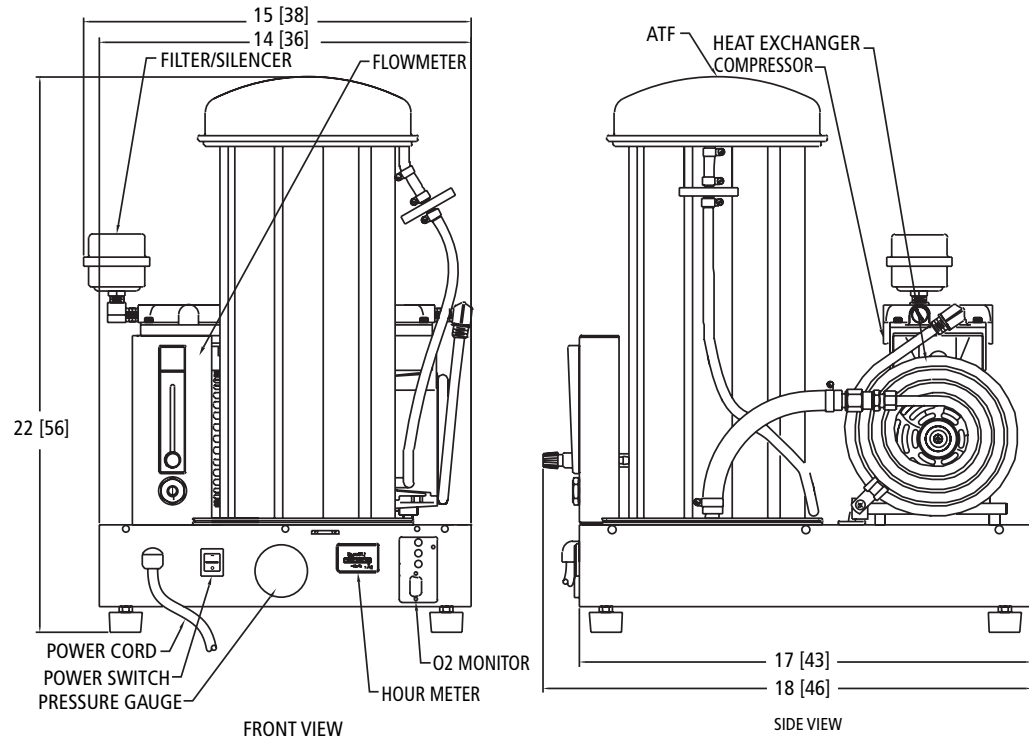

Figure 6.1: Mechanical Outline Drawing - Workhorse-15

7.0 Service Parts

Service parts listed below can be obtained directly from AirSep. Tubing can generally be obtained locally; specifications are listed below. Always replace tubing with equal or better specifications. Other parts are not considered regular service items. Please contact AirSep directly for further information on other parts.

7.1 SERVICE PARTS

Description	Part Number	Quantity
ATF Module, 120 V, 60 Hz	1242V-SEQ	1
ATF Module 220/240 V 50/60 Hz	1498V-SEQ	1
Compressor 120 V/60 Hz	1313-SEQ	1
Compressor Rebuild Kit, 120 V, 60 Hz	3197-SEQ	1
Cylinder Walls (aka Cylinder Sleeves) for 120 V, 60 Hz compressor (if needed)	3411-SEQ	2
Compressor 220/240 V 50 Hz	1314-SEQ	1
Compressor Rebuild Kit 220/240 V 50 Hz	3295-SEQ	2
Compressor 220 V, 60 Hz	3178-SEQ	1
Compressor Rebuild Kit 220 V, 60 Hz	3197-SEQ	1
Cylinder Walls (aka Cylinder Sleeves) for 220 V, 60 Hz compressor (if needed)	3411-SEQ	2
Compressor Inlet Filter	3308-SEQ	1
Compressor Inlet Filter Element	3309-SEQ	1
Pressure Relief Valve	1368-SEQ	1
Vibration Mount	3548-SEQ	4
Cabinet Filter (on units with cover)	1496-SEQ	1
Oxygen Monitor, 120 V	7393-3-SEQ	1
Oxygen Monitor, 220 V	7393-4-SEQ	1
Compressor Discharge Pressure (compressed air) Test Kit	7389-SEQ	1

Table 7.1: Workhorse-15 Service Parts

7.2 REPLACEMENT TUBING

Tube Size (ID x OD)	Construction	Max. Working Pressure (psig)	Temperature Range (°F)
1/2" x 7/8"	Reinforced Silicone	141	-40 to 175
1/4" x 1/2"	PVC	70	-40 to 175

1/2" ID x 10' Hose part number 9155-SEQ

1/4" ID x 10' Hose part number 9160-SEQ

Table 7.2: Replacement Tubing

7.3 TECHNICAL SUPPORT

For assistance in troubleshooting or repairing the unit, or to order replacement parts, contact the AirSep Commercial Products Service Department by telephone. In the USA or Canada, call 1-800-320-0303. Outside the USA or Canada, call (716) 691-0202. Send fax inquiries anytime to (716) 564-2717. Address written inquiries to:

AirSep Corporation
 260 Creekside Drive
 Buffalo, NY 14228-2075
 USA
 Attention: Commercial Products Service Department
 E-mail: info@airsep.com

Visit www.airsepcpd.com to know about our complete range of standard Oxygen Generators.

AirSep Corporation
260 Creekside Drive
Buffalo, NY 14228-2075 U.S.A.
Tel: (716) 691-0202 ■ Fax: (716) 691-1255
info@airsep.com
www.airsepcpd.com



**CAIRE**[®]

© 2019 AirSep Corporation. All Rights Reserved.
AirSep reserves the right to discontinue its products, or change the prices, materials, equipment, quality, descriptions, specifications and/or processes to its products at any time without prior notice and with no further obligation or consequence. Any rights expressly stated herein are reserved by us, as applicable.

AIRSEP[®]

1432N-SEQ C