

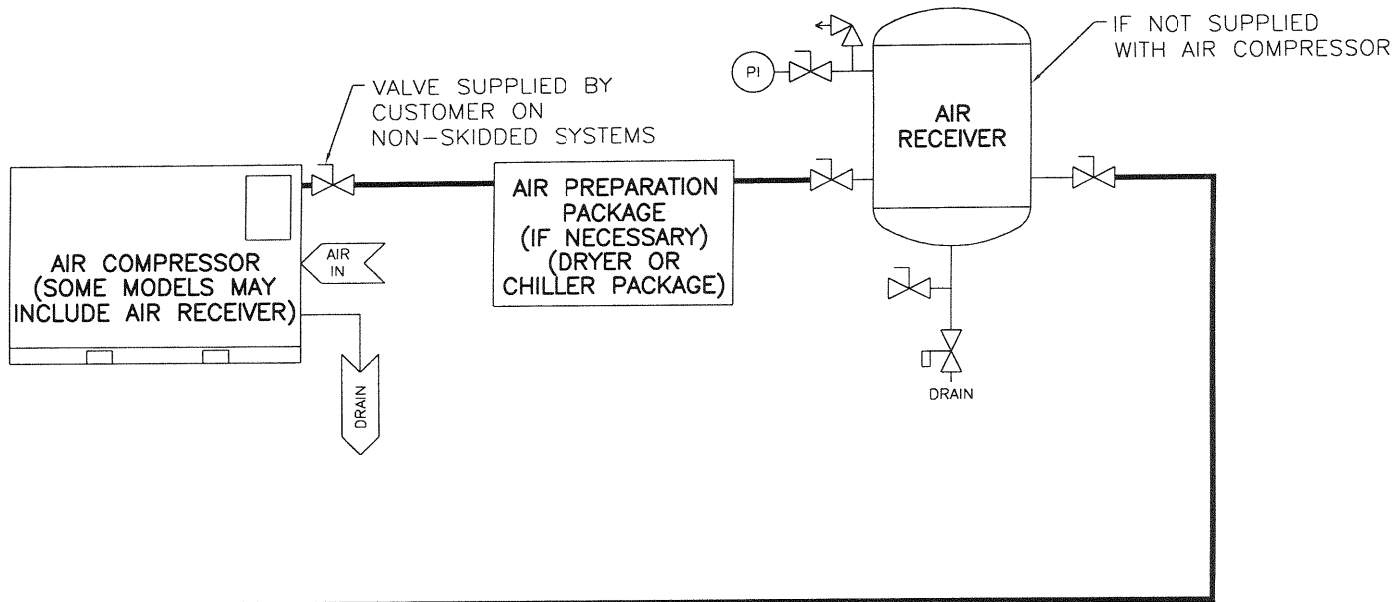







AIRSEP TYPICAL PACKAGE PLANT PROCESS & INSTRUMENTATION DIAGRAM (SKIDDED OR NON-SKIDDED)



LEGEND	
	CONDENSATE DRAIN
	MANUAL VALVE
	NEEDLE VALVE
	PRESSURE REGULATOR
	SAFETY RELIEF VALVE
	PRESSURE INDICATOR
	SLUG
	FILTER ASSEMBLY

— SUPPLIED BY CUSTOMER ON
NON-SKIDDED SYSTEMS

